

# Water Supply & Fire Protection Systems

# 11

Section II - Engine Company Operations



**Municipal Water Delivery Systems**

**Fire Detection and Alarm Systems**

**Standpipe Systems**

**Water Based Fire Protection Systems**

**Automatic Fire Sprinklers**

**Non-Water Based Fire Protection Systems**



*Intentionally Left Blank*



# Chapter 11 Table of Contents

Objectives .....	11-1
Introduction.....	11-2
Municipal Water Delivery System.....	11-3
Supply Systems .....	11-3
Distribution Systems.....	11-3
Fire Hydrants .....	11-4
Detection and Alarm Systems.....	11-6
Local vs. Monitored Alarm Systems.....	11-6
Manual Alarm Devices .....	11-6
Automatic Alarm Devices.....	11-7
Fire Alarm Panel.....	11-8
Standpipe Systems .....	11-11
Class I Systems.....	11-11
Class II Systems.....	11-11
Class III Systems .....	11-11
Types of Standpipe Systems .....	11-12
Connecting to the Standpipe System.....	11-13
Water-Based Sprinkler Systems.....	11-16
Wet-pipe System.....	11-17
Dry-pipe systems .....	11-17
Pre-Action Systems .....	11-19
Deluge Systems .....	11-20
Automatic Fire Sprinkler System Components.....	11-21



Sprinkler Heads..... 11-21

Sprinkler System Piping ..... 11-23

Sprinkler System Control Valves..... 11-23

Indicating Valves..... 11-24

Non-indicating Valve ..... 11-25

Check Valve (Clapper Valve)..... 11-25

Water Flow Alarm..... 11-26

Fire Protection System Pump ..... 11-26

Shutting Down Fire Protection Systems ..... 11-27

Non-Water Based Fire Protection Systems..... 11-29

    Halogenated Agents ..... 11-29

    Halon Replacement Agents and Systems..... 11-30

    Carbon Dioxide Systems ..... 11-30

    Chemical Extinguishing Systems ..... 11-31

Summary ..... 11-33

Media & Link Index..... 11-34

References..... 11-35

    Credits..... 11-35

Revisions/Updates..... 11-36



# Objectives

- Identify the major components of modern water delivery systems.
- Describe detection and alarm systems.
- Identify the classes and types of standpipes.
- Describe the procedure for connecting to an FDC
- Describe the procedure for shutting down and restoring a standpipe system
- Identify the system types and basic operating principles of water-based fire protection systems.
- Identify and describe the major components of automatic fire sprinkler systems.
- State the effectiveness of wet pipe sprinkler systems for the protection of life and property.
- Identify the characteristics of upright, pendant, and horizontal sprinkler heads.
- Describe the temperature ratings and associated color ratings for sprinkler heads.
- Identify system types and concepts for fire suppression without water.

# Introduction



Figure 11-1 Benjamin Wyatt

The world’s first recognizable sprinkler system was installed in the Theatre Royal, Drury Lane in the United Kingdom in 1812 by its architect Benjamin Wyatt, [Figure 11-1](#). The apparatus consisted of a cylindrical airtight reservoir of approximately 25,000 gallons fed by a 10 inch water main, which branched to all parts of the theatre. A series of smaller pipes fed from the distribution pipe were pierced with a series of ½ inch holes which pour water in the event of a fire.

From 1852 to 1885, perforated pipe systems were used in textile mills throughout New England as a means of fire protection. However, they were not automatic systems; they required a person to open the valve for water distribution. Inventors first began experimenting with automatic sprinklers around 1860. The first automatic sprinkler system was patented by Philip W. Pratt of Abington, MA, in 1872. Henry S. Parmalee of New Haven, Connecticut is considered the inventor of the first automatic sprinkler head. Parmalee improved upon the Pratt patent and created a better sprinkler system, [Figure 11-2](#). In 1874, he installed his fire sprinkler system into the piano factory that he owned. Frederick Grinnell improved Parmalee’s design and in 1881 patented the automatic sprinkler that bears his name. He continued to improve the device and in 1890 invented the glass disc sprinkler, essentially the same as that in use today.

Until the 1940’s, sprinklers were installed almost exclusively for the protection of commercial buildings, whose owners were generally able to recoup their expenses with savings in insurance costs. Over the years, fire sprinklers have become mandatory safety equipment in some parts of North America, in certain occupancies, including, but not limited to newly constructed hospitals, schools, hotels and other public buildings, subject to the local building codes and enforcement.

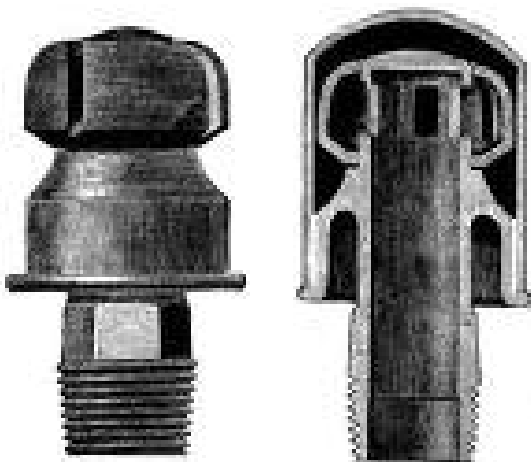

Figure 11-2 Early Sprinkler Design

Time is the most important commodity in fire protection. The fire protection system objectives are to reduce reaction time, evacuation time, response time, and suppression time. Fire alarm systems coupled with automatic suppression systems have significantly reduced life and property loss from fire. While early fire protection systems were often unrefined and unreliable, modern systems are much more efficient and reliable when properly maintained. Built-in fire safety systems and common-sense fire safety techniques provide a meaningful approach to combating fire.



# Municipal Water Delivery System

As water is the lifeblood of every community, it is necessary to supply water for domestic usage and fire protection considerations. This is accomplished through a combination of supply and distribution systems.

## Supply Systems

The supply systems provide stored water to the distribution systems. Supply systems are pressurized by gravity, pump, or a combination of both. Gravity systems operate with a water source that is at a higher elevation than the area to be serviced. The pressure of the water system delivered by a gravity system is determined by the elevation of the source above the area of usage at a 0.433 psi pressure gradient per foot of elevation. Pump systems use centrifugal pumps to supply a distribution system when a water source is below or at the same elevation as a service area.



Figure 11-3 Lake Murray / Alvarado Water Facility

The City of San Diego uses a combination system to deliver nearly three million gallons of water to its citizens per day. Man-made lakes and reservoir tanks are fed by aqueducts from northern California and the Metropolitan Water District, which gets water from the Colorado River. Most of the City of San Diego's water is supplied by gravity, [Figure 11-3](#). Water in areas such as La Jolla, Del Cerro, and Paradise Hills is supplied by pumping to a storage reservoir or tank at a higher elevation in the community, [Figure 11-4](#). Gravity is then used to deliver water to the consumer from this secondary elevated reservoir.

## Distribution Systems

Water is delivered to consumers and fire hydrants throughout the City of San Diego by a system of pipes and valves. The system can be segregated into two distinct systems of transmission and distribution. Transmission lines are designed to move water from the supply source to distribution lines in the areas of usage. Pipes ranging from 16-66 inches in diameter are looped to form a grid system. Distribution lines range from 8-16 inches in diameter. Distribution lines loop through the area of use to form a smaller grid system within the transmission grid system. Only in areas where topography prevents a grid system are water lines run as a branch system with "dead ends" to service the area. Water mains that supply individual consumers and fire hydrants are looped lines tapped off of the distribution lines creating an even smaller grid system. Control valves are placed on transmission lines  $\frac{1}{2}$  to 1 mile apart. Control valves on the distribution system are strategically placed so that no

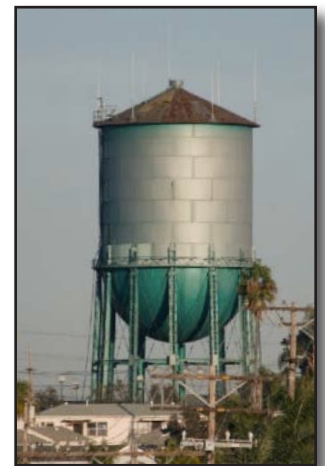
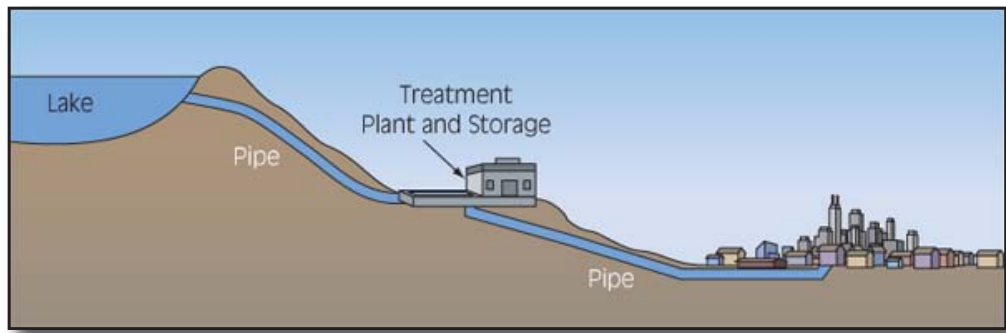
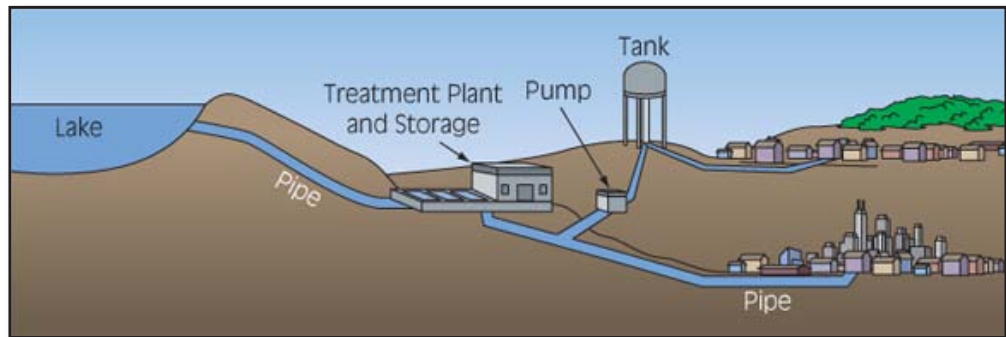

Figure 11-4 North Park Water Tower



Gravity Fed Water System



Combination Gravity & Pump Fed Water System

more than 30 homes and 2 fire hydrants are out of service at any time the valve must be closed. The distribution grid is designed with the fire protection consideration of supplying the fire flow requirements for individual fires. The system is not designed to meet the fire flow requirements for large wildfire or large urban interface fire situations.

## Fire Hydrants

### Dry Barrel Hydrants

There are essentially two types of fire hydrants used in the fire service, the dry barrel and the wet barrel. Dry barrel hydrants are mainly used in colder climates where freezing can occur. The valve for the hydrant outlets is located on the water main or below the frost line. The inside of the hydrant remains dry until use, and drains after use, [Figure 11-5](#).

### Wet Barrel Hydrants

Wet barrel hydrant bodies are filled with water under pressure at all times. Each wet barrel hydrant outlet has a valve for water control. The City of San Diego uses wet barrel hydrants. The standard hydrant design for residential areas use one 2 ½ inch outlet and one 4 inch outlet. The standard hydrant design for commercial areas uses one 2 ½ inch and two 4 inch outlets. Hydrant designs may vary slightly based on the age of the community or the anticipated fire flow requirements of the area. Fire hydrants are to be no more than 600

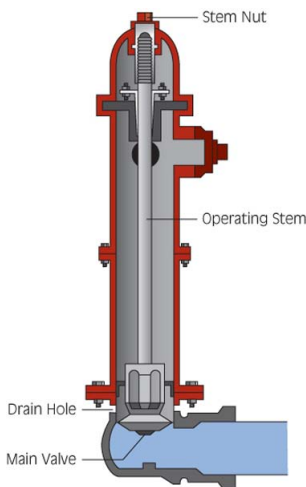
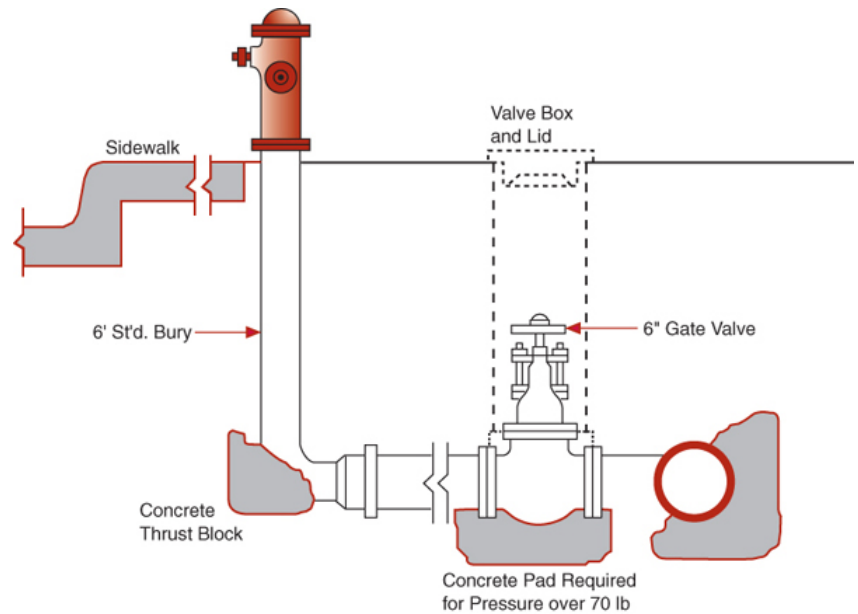
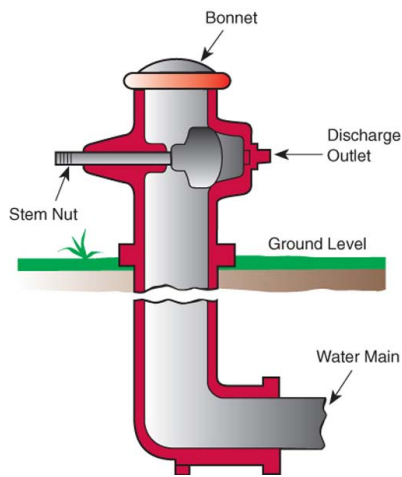

Figure 11-5 Dry Barrel Fire Hydrant





Wet Barrel Fire Hydrant (2 images)

feet apart in the City of San Diego. The hydrant is positioned with the 4 inch outlet facing the street and the lowest outlet of the hydrant must be a minimum of 18 inches above the ground. No obstructions can be within 3 feet of the hydrant. No vehicle may park within 15 feet of a fire hydrant except when a licensed driver remains in the driver's seat able to move the car or if the vehicle is a fire department vehicle.



To increase visibility for firefighters, blue reflectors are placed in the middle of the roadway directly in front of the fire hydrants, Figure 11-6. These reflectors assist with visibility during day and night.

Figure 11-6 Fire Hydrant Road Reflectors

### Low Pressure / High Volume Hydrants

There are several white-painted or unpainted fire hydrants throughout the city. The City of San Diego Water Department refers to these hydrants as "ports." These hydrants are low pressure/high volume units that are utilized to maintain water pressure in the mains during repairs or large scale emergencies. While they are normally used by Water Department personnel, a fire department engine can hook up to the "port" and pump into an adjacent yellow hydrant to maintain acceptable water pressure in the main, Figure 11-7.



Figure 11-7 High Volume / Low Pressure Fire Hydrant

# Detection and Alarm Systems



A fire detection and alarm system is a key element among the fire protection features of any building. Because most fire deaths in the United States result from building fires, the use of fire detection and alarm systems in buildings can help to significantly reduce the loss of life from fire. A fire alarm system can help limit property fire losses in buildings, as well. Fire alarm design and installation requirements are established by NFPA 72, National Fire Alarm Code.

Audible and visible notification devices are used to alert occupants of a building that they need to evacuate or relocate to a safe area. Audible notification devices are generally horn devices with a decibel setting sufficient to alert occupants. Visible notification devices are generally strobe light configurations designed to supplement audible devices.

## Local vs. Monitored Alarm Systems

Fire alarm systems can be designed as local alarm systems or monitored systems. A local alarm system will report only on the premises, in an effort to alert the building occupants of a fire emergency via audible and visible notification devices. A monitored system uses the above to notify occupants of a fire emergency and a method to report the alarm to the local fire department. Monitored alarm systems are categorized as central station, proprietary, and remote station alarm systems.

## Manual Alarm Devices

Initiation devices used to activate the fire alarm system are categorized as manual or automatic devices. Manual pull stations are examples of manual initiating devices. These devices are either single action or dual action. Single action devices require a simple pull to activate the alarm (i.e. pull stations with a glass rod keeping the device closed require the user to simply pull the handle), Figure 11-8. Dual action devices require a user to complete two actions



Figure 11-8 Single Action Manual Pull Station



Figure 11-9 Dual Action Manual Pull Station

to activate the alarm (i.e. pull stations that require the user to push a panel in, then pull handle down), [Figure 11-9](#).

## Automatic Alarm Devices

Automatic initiating devices do not require human intervention to activate the fire alarm. Examples of automatic initiating devices are: heat detectors, ionic smoke detectors, photoelectric smoke detectors, infrared and UV flame detectors, and gas detectors.



Figure 11-10 Heat Detector

### Heat Detectors

Heat Detectors operate by detecting the heat of a fire at a fixed temperature or as the rising temperature builds at a rapid rate. Heat detectors can be used as part of a suppression system such as a sprinkler system, or can operate a fire protection device such as an alarm, [Figure 11-10](#). Heat detectors are slow to detect fire and should not be used for life safety. They are, however, inexpensive and have a low rate of false alarms.

### Smoke Detectors

Smoke and toxic gases are the leading killers of people in residential structural fires. Smoke detectors have greatly improved residential life safety by detecting and alerting building occupants to the harmful effects of fire. Smoke detectors are the most prevalent automatic detection system in use in homes across North America, yet many occupants do not understand how to maintain them or how they work, [Figure 11-11](#). It is important for firefighters to understand the operation and types of smoke detectors in order to assist owners and occupants with questions and solutions.



Figure 11-11 Smoke Detector

Smoke detectors can be powered by battery, permanent (hard) wiring, or a combination of both where the battery is used to back up the permanent power supply. Smoke detectors work primarily on two principles: ionization and photoelectric.

#### *Ionization Smoke Detectors*

Ionization smoke detectors are the most common type of smoke detector found in homes and apartments. These detectors use a radioactive element that emits ions into a chamber. The positive and negative ions are measured on an electrically charged electrode. When smoke enters the chamber, the flow of ions to the electrode changes and the alarm is activated, [Figure 11-12](#).

Ionic detectors are reliable but can be activated by cooking, steam from a shower and dust buildup. Some people classify these activations as false alarms, but in actuality, these activations indicate the detector is working as designed. Most ioniza-

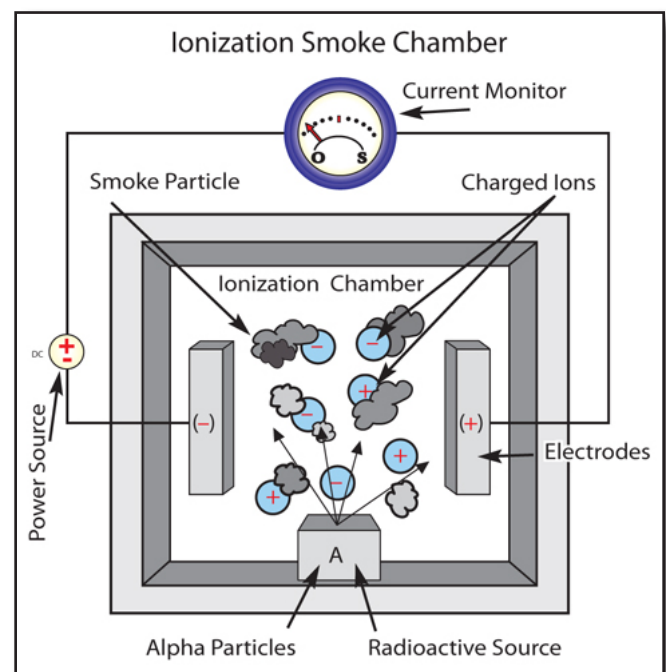

Figure 11-12 Ionization Smoke Detector

tion smoke detectors will reset themselves automatically once the smoke has cleared. A smoke detector that continuously “chirps” typically indicates that the battery is low.

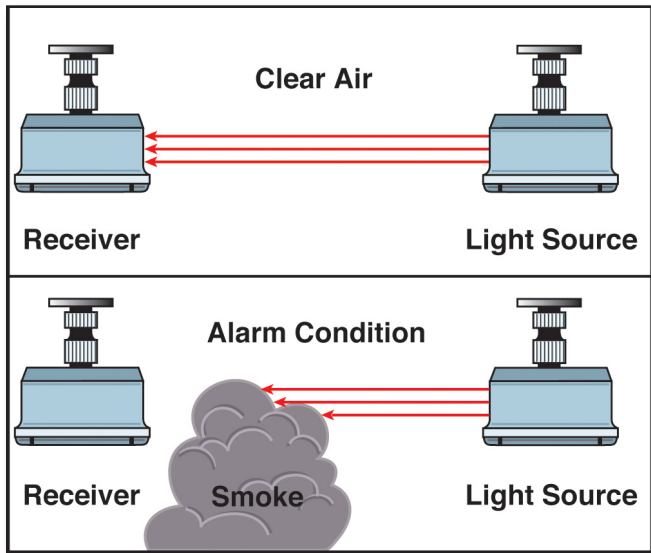

Figure 11-13 Photoelectric Smoke Detector

### Photoelectric Smoke Detectors

A photoelectric smoke detector operates by sending a beam of light to a sensor. When the smoke particles obscure the beam of light from the sensor, the alarm will sound, Figure 11-13. Photoelectric detectors are activated by visible smoke and are appropriate for areas where smoke may develop but dissipate visually, such as in a cooking area. Like ionization detectors, dust and steam may activate the alarm. If the detector is exposed to oily or heavy smoke, the detector may not reset once the smoke clears as the smoke may form a film on the sensor and obscure the light from reaching it.

### Flame Detectors

Flame detection devices detect flames or light waves using either ultraviolet (UV) or infrared (IR) technology. These detectors are very sensitive and quick to alarm. They are used to protect petroleum and chemical facilities where fast and high temperature fires can occur.

### Gas Detectors

Gas-sensing detectors are designed to find the presence of a certain gas or gases prior to their reaching a concentration that can cause danger. A flammable gas detector would identify the presence of the gas before it reached its ignitable concentration. Other gases, such as carbon monoxide, would be detected prior to reaching a level that could cause injury or death. Gas detectors can be permanently mounted or portable devices.



Figure 11-14 Carbon Monoxide Gas Detector

Carbon monoxide detectors for the home are popular and are even required in some communities, Figure 11-14. Like smoke detectors, they have saved many lives. Most CO detectors provide an early warning alarm, usually an intermittent beep, when low-level CO is detected. Some CO detectors have an LED display that indicates the level (in parts per million) of CO being detected. Since CO is odorless and colorless, it is necessary to use the portable gas detectors carried on fire apparatus to check for its presence, and the presence of other gases, in the structure when a gas alarm is sounding.

### Fire Alarm Panel

Fire alarm systems have evolved and improved drastically over the past decade. Current fire alarm systems now consist of any combination of fire de-



tection and prevention devices, such as smoke detectors, CO detectors, heat detectors, sprinkler systems, tamper devices, and pull stations.

The fire alarm panel, or annunciator panel, is the centralized computer system that coordinates and displays the function of the alarm system in a building, [Figure 11-15](#). Although fire alarm panels range from very simple (residential applications) to very complex (high-rise buildings), they generally all operate in a similar manner which all firefighters should be familiar with.

## Alarm Panel Signals

Fire alarm panels typically indicate the hazard via a colored lighting display, a message screen, or a combination of both. The following is a general description of the alarm system status and the message displays that may be encountered.

**System Normal** – No alarms, hazards or trouble detected

- Light – Green
- Alarms - None
- Message Display – “Normal”
- Action - None

**System Trouble** – Used to indicate the presence of a circuit break or ground within the system. Also may indicate a dirty or expired detector in the system.

- Light – Yellow
- Alarms – Tone alert at the panel only
- Message Display – “Trouble”
- Action – Notify building manager or alarm company, typically does not initiate a fire department response.

**Supervisory Condition** – Indicates a problem with the condition of the buildings sprinkler system or some other system that is used for life & property.

- Light – Yellow
- Alarms – Steady tone alert at the panel only
- Message Display – “Supervisory”
- Action - Notify building manager or alarm company, typically does not initiate a fire department response.

**Active Alarm Condition** – Indicates a fire, detector, sprinkler system, or pull station activation.

- Light – Red
- Alarms – Full building alarm activation via horns, strobes, and audio evacuation messages as well as pre-programmed actions within the building. HVAC systems may be turned on or off, doors may close, and elevators



Figure 11-15 Alarm Panel



may return to the lobby. Additionally, an offsite alarm company shall automatically be notified, who in turn notifies the fire department.

- Message Display - “Fire” / “Pull Station 4th Floor” / “Sprinkler Activation Rm 905” / “Heat & Smoke Detectors 4th Floor” / etc.
- Actions – Mitigate Hazard and Reset Alarm

### Common Alarm Panel Buttons

There are three primary buttons found on most all fire alarm panels which firefighters must know how to operate, Figure 11-16.

- **Acknowledge or “ACK”** – Allows the firefighter to indicate to the alarm panel that you have observed the presence of the alarm.
- **Silence** – Allows the firefighter to silence the buildings audible alarm system (horns), but does not reset the alarm.
- **Reset** – Allows the firefighter to reset and clear all acknowledged alarms, troubles, and supervisory conditions.

Although the fire department responds to many false alarms, we must respond and handle each ringing alarm incident as if it were an actual fire. Upon arrival to a ringing alarm, one firefighter must report to the alarm panel while the investigation into the source of the alarm is being investigated by the other firefighters. The firefighter at the alarm panel should “acknowledge” the

alarms and communicate them to their crew. Once the alarms have been “acknowledged,” the alarm system may be silenced to reduce the level of noise at the scene and help to calm any occupants who may be evacuating. Once the source of the alarm has been located and mitigated, the system can be reset. If the alarm system cannot be reset due to a malfunction and it is determined that there is no hazard, the building manager or security must provide a person to conduct a fire watch until the system is functioning again.



Figure 11-16 Alarm Panel Display



# Standpipe Systems

Standpipe systems are fixed piping systems with associated equipment that transports water from a reliable water supply to designated areas of buildings where hoses can be deployed for fire fighting. Such systems are typically provided in tall and large buildings. The NFPA standard for regulating the design, installation, and testing of standpipe systems is NFPA 14, Standard for the Installation of Standpipe, Private Hydrant, and Hose Systems.

Standpipe systems are designated as Class I, Class II, and Class III. Some sources refer to a fourth class of system called a “combined” system; however, combined systems are simply Class I or Class III standpipe systems that also supply water to a sprinkler system.

## Class I Systems

Class I systems are typically required in buildings that have more than three stories above or below grade. These systems are generally intended for use by fire departments. Fire department pumpers are the water supply for these systems. These systems have a fire department connection at street level, with a minimum of two 2 ½-in. inlets. The riser pipe is dry, with 2 ½-in. outlets on each floor above or below the ground floor, including the roof, [Figure 11-17](#). The risers are placed so that 100 feet of hose can be stretched to within 30 feet of any portion of the structure. Expansive buildings require multiple risers to deliver water. NFPA 14 requires systems installed prior to 1993 to deliver 65 psi at the most remote outlet. Systems installed after 1993 are required to deliver 100 psi at the most remote outlet.



Figure 11-17 Class I Standpipe System

## Class II Systems

Class II systems are often required in large un-sprinklered buildings. These systems are connected directly to a water source. The outlets for this system provide 1 ½-in. hose connections, 100 feet of firefighting hose, and 50 GPM nozzle for use by building occupants, [Figure 11-18](#). A growing concern regarding the wisdom of having building occupants fighting fire instead of evacuating has led to a decline of Class II system installation. NFPA 14 requires Class II systems to deliver 65 psi at the most remote outlet. Pressure regulating devices are required when outlet pressure exceeds 100 psi.



Figure 11-18 Class II Standpipe System

## Class III Systems

Class III systems combine the features of Class I and Class II systems. They are generally intended for use by fire departments, fire brigades, and perhaps building occupants. Because of their

multiple uses, Class III systems are provided with both Class I and Class II hose connections. This is sometimes accomplished by using 2 ½-in. hose valves with removable 2 ½-in. to 1 ½-in. reducers, [Figure 11-19](#). Class III systems include a fire pump for pressure delivery at the most remote outlet. NFPA 14 requires systems installed prior to 1993 to deliver 65 psi at the most remote outlet. Systems installed after 1993 are required to deliver 100 psi at the most remote outlet. Pressure regulating devices are required when outlet pressure exceeds 175 psi.



Figure 11-19 Class III Standpipe System

## Types of Standpipe Systems

In addition to being subdivided into classes that delineate the intended use of a system, standpipe systems are also classified by “type.” These types delineate the basic characteristics of systems, that is, whether the piping will be filled with water or not, and whether the water supply for firefighting will be automatically available or not.

The 1993 edition of NFPA 14 completely redefined system types. The result was the creation of five categories, as follows:

### Automatic-Wet Systems

Automatic-wet systems have piping that is filled with water at all times and have an automatically available water supply capable of supplying the water demand necessary for fire fighting, [Figure 11-20](#).

### Automatic-Dry Systems

Automatic-dry systems have piping that is normally filled with pressurized air. These systems are arranged, through the use of devices such as a dry-pipe valve, to automatically admit water into system piping when a hose valve is opened, and they are connected to an automatically available water supply that is capable of supplying the water demand necessary for fire fighting.



Figure 11-20 Automatic-Wet Standpipe Connection

### Semiautomatic-Dry Systems

Semiautomatic-dry systems have piping that is normally filled with air that may or may not be pressurized. These systems are arranged through the use of devices, such as a deluge valve, to admit water into system piping when a remote actuation device located at a hose station, such as a pull station, is operated. They also have a pre connected water supply that is capable of supplying the water demand necessary for fire fighting.

### Manual-Dry Systems

Manual-dry systems have piping that is normally filled with static air and do not have a pre connected water supply. A fire department connection must be used to manually supply water for fire fighting, [Figure 11-21](#).





## Manual-Wet Systems

Manual-wet systems have piping that is normally filled with water for the purpose of allowing leaks to be detected. The water supply for these systems is typically provided by a small connection to domestic water piping, and it is not capable of supplying fire fighting water demands. A fire department connection must be used to manually supply water for fire fighting.

In summary, wet systems have water-filled piping and dry systems do not. Automatic systems provide a water supply for firefighting by simply opening a hose valve. Semiautomatic systems are connected to a water supply for firefighting but require activation of a device at a hose valve in addition to opening the valve to get water. Manual systems do not have a pre connected water supply for fire fighting, and these systems must be manually supplied by connecting hoses from a fire department pumper to a fire department connection.



Figure 11-21 Manual-Dry Standpipe Connection

## Connecting to the Standpipe System

Connecting to a building's standpipe system calls for connecting a minimum of two, 2 1/2" hose lines from the fire engine to the fire department connection (FDC), [Figure 11-22](#). Shutoff butts need to be secured and attached to the hose lines prior to advancing them to the FDC. In the event that the building you are supplying water to is over 20 stories in height, the triple jacket, high-pressure hose shall be used if available. If you are using this high-pressure hose, shut-off butts shall NOT be attached, as the diameter of the open shut-off butt narrows and decreases water pressure that may be needed on upper floors.



Figure 11-22 2 1/2" Hoseline Connected to the FDC

Once at the FDC, remove the standpipe inlet protection plug (cap) either by unscrewing it, or breaking it out with a pocket spanner. If the plug comes completely off, lay it down on the ground against the building with the male threads down.

A series of five checks must be performed on the inlet. If this is the first line into the system and there are two inlets, remove both plugs (caps) and check both inlets. The FDC inlets need to be checked for the following:

1. **Swivel** - Manipulate the swivel to make sure that it will spin.
2. **Threads** - Check the condition of the threads and whether they will accept the shutoff butt.
3. **Gasket** - Look for and check the condition of the gasket just like any other female swivel.
4. **Obstructions** - Check for and clear any obstructions found in the inlet.

## 5. Clapper Valve - Push on the clapper valve to see if it is functional.

Connect the shutoff butt to the most difficult inlet to reach: the bottom inlet on a vertical stack, or the most difficult inlet to reach on a horizontal system. Make all connections on the FDC spanner tight. Initially secure the shutoff butt by hand until the coupling is set and then use a pocket spanner - (clockwise from the swivel's perspective). Ensure that the shutoff butt is in the closed position, stand in a safe area and call for water. Notify personnel above that the system is getting charged. Slowly open the shutoff butt and fix any leaks and/or kinks in the area.



Figure 11-23 Double Female & Male Adaptor to FDC



Figure 11-24 Twisting Hose to Connect to FDC



Figure 11-25 Standpipe Obstruction

### FDC Problems

It is fairly common to find swivels on older FDC's to have corrosion or damage, preventing the female coupling on the FDC from spinning. In this event, two techniques may be utilized to overcome this problem.

The first method is to obtain a 2 1/2" double female and 2 1/2" double male from the apparatus and attach them to each other. Place the male end of this new connection into the frozen female coupling on the FDC and connect. You may now connect the male end of your shut-off butt to the new double female connected to the FDC, [Figure 11-23](#). Spanner tight all connections.

The second method, which is often faster, is to twist the 2 1/2" hose line with shut-off butt in a counter clockwise manner approximately 4 full turns. Then, place the twisted hose line onto the FDC and untwist in a clockwise manner until the hose is completely connected to the FDC, [Figure 11-24](#). Spanner tight all connections.

Another common issue with FDC's is trash, debris and other obstructions that may be encountered inside the plumbing. Because the FDC is located at street level, it is not uncommon to find trash, dirt, rocks, food, and even drug paraphernalia jammed into the system pipes. Do not attempt to remove this debris by hand, instead use a spanner, pliers or other object, [Figure 11-25](#).



## Restoring the Standpipe System

Standpipe Systems must be restored after being used. For wet standpipe systems, firefighters merely need to close the standpipe valve and disconnect their hoses. For dry standpipe systems, the standpipe plumbing must be drained.

The following steps should be taken to drain a dry standpipe system:

- The hose lines supplying the standpipe inlet from the engine company must be shutdown and disconnected.
- A firefighter shall go to the highest standpipe outlet, typically the roof, and open the discharge valve.
- Because the clapper valves in the ground level FDC prevent the system from being drained, a firefighter must take a section of 2½” hose to the second floor FDC and attach the line to the discharge port.
- The 2½” hose shall be led to a drain or the outside of the building, then the discharge on the second floor shall be opened allowing all the water in the standpipe plumbing at or above this level to drain out of the system.
- Once the system has drained to the second floor, a firefighter at the ground level FDC will slowly place a round handle, typically a spanner, into one of the FDC inlets to allow the system to drain completely.
- When the system has been drained, restore all valves to the closed position and replace all caps and/or plugs.

*Note - The reason for draining the water from the second floor is due to the head pressure, or weight of the water, on the clapper valves at the FDC inlet on the ground floor. Two or more floors of head pressure on the clapper valves make it extremely difficult to insert a round handled tool to drain the system.*

In all cases, it is recommended that the building owner contact a private fire protection system company to certify that the system has been restored properly and is in working order whenever the system has been used by the fire department.



# Water-Based Sprinkler Systems

Water is the most widely used and available fire-extinguishing agent. Water is inexpensive, abundant, and effective in fire suppression. Water as an agent is safe, nontoxic, relatively noncorrosive, and stable. Water can be applied as an extinguishing agent with occupants in compartments.

NFPA 13, Standard for the Installation of Sprinkler Systems, is the main document that covers the design and installation of sprinkler systems. A sprinkler system is described as a combination of underground and overhead piping that is connected to an automatic water supply and is installed throughout the building. Sprinklers are attached to the overhead piping in a systematic pattern and a valve controlling each riser is located either directly on the system riser or in the supply piping. The system is usually activated by heat from a fire and discharges water over the fire area.

In situations where the sprinkler system was working properly, the National Fire Protection Association doesn't have a record of any fire killing more than two people when it occurred in a completely sprinklered public, educational, institutional, or residential building. In cases where fatalities occur in a building equipped with fire sprinklers, the deceased were almost always in very close contact with the fire and were burned severely before the sprinkler activated (i.e. smoking in bed, explosions, etc.). Sprinklers typically reduce the chances of dying in a fire - and reduce average property loss - by one-half to two-thirds in any kind of property.

The odds of a sprinkler activating due to a defect are about 1 in 16 million. Fire sprinklers have a long history of proven dependability and reliability. Although sprinklers can be damaged and activated through intentional or accidental abuse, it's very rare. Sprinkler piping is no more likely to leak than the existing plumbing piping in any building.

Statistics show that in fires where sprinklers operated, they were effective in 96% of the cases. Of the 4% cases in which the sprinklers were not effective, the causes for ineffectiveness were: water not reaching the fire, not enough water released, damaged component, lack of maintenance, manual intervention defeated the system, and poor system design. Usually only one or two sprinklers are required to control a fire. Statistics show when wet-pipe sprinklers operated, 89% of the fires involved only one or two sprinklers.

Most water-based fire protection systems fall within one of four categories. These include wet pipe, dry pipe, pre action, and deluge with the wet pipe being the most common.

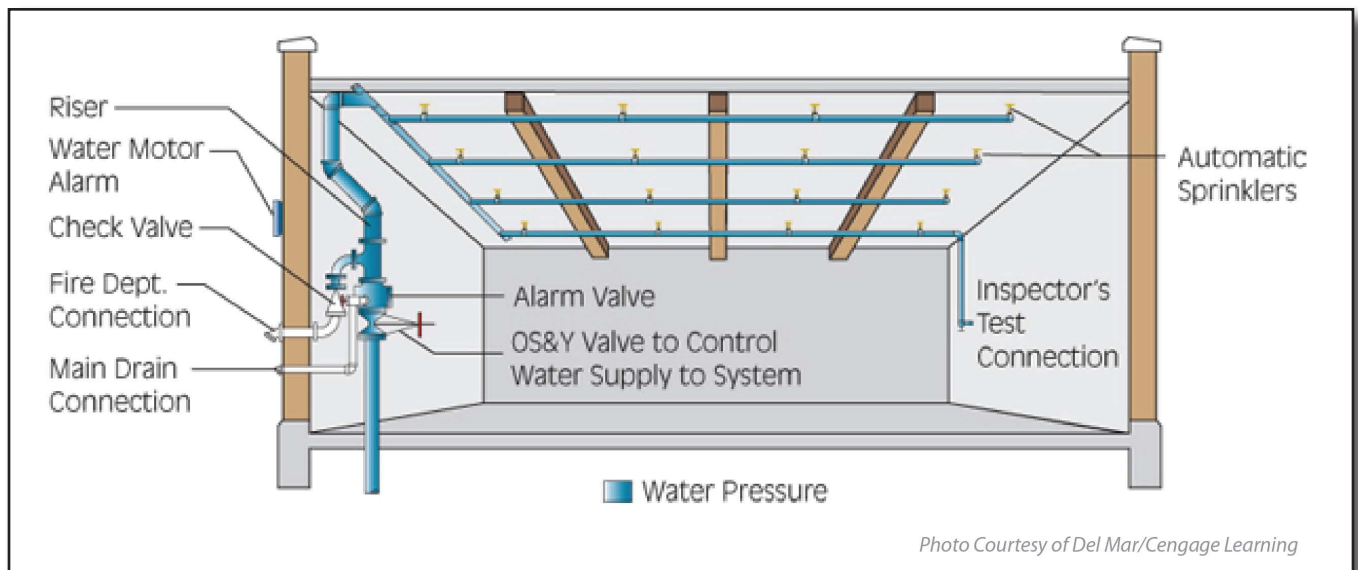

Wet-Pipe Sprinkler System

## Wet-pipe System

Wet-pipe systems are the easiest to design, install and the simplest to maintain. Wet-pipe systems contain water under pressure at all times and utilize a series of closed sprinklers. Each closed-head sprinkler is held closed by either a heat-sensitive glass bulb or a two-part metal link held together with fusible alloy. The glass bulb or link applies pressure to a pip cap which acts as a plug. This plug prevents water from flowing until the ambient temperature around the sprinkler reaches the design activation temperature of the individual sprinkler head. In a standard wet-pipe sprinkler system, each sprinkler activates independently when the predetermined heat level is reached. Because of this, the number of sprinklers that operate is limited to only those near the fire, thereby maximizing the available water pressure over the point of fire origin.

Sprinkler activation will do less damage than a fire department hose stream, which provides approximately 250 GPM. A typical sprinkler used for industrial manufacturing occupancies discharge about 20-40 GPM. However, a typical Early Suppression Fast Response (ESFR) sprinkler at a pressure of 50 psi will discharge approximately 100 GPM. In addition, a sprinkler will usually activate between one and four minutes after the ignition of a fire. The fire department typically takes at least five minutes to arrive at the fire site after receiving an alarm, and an additional ten minutes to set up equipment and apply hose streams to the fire. This additional time can result in a much larger fire, requiring much more water to achieve extinguishment.

## Dry-pipe systems

Dry pipe systems are installed in spaces in which the ambient temperature may be cold enough to freeze the water in a wet pipe system, rendering the system inoperable. Dry pipe systems are most often used in unheated buildings, in

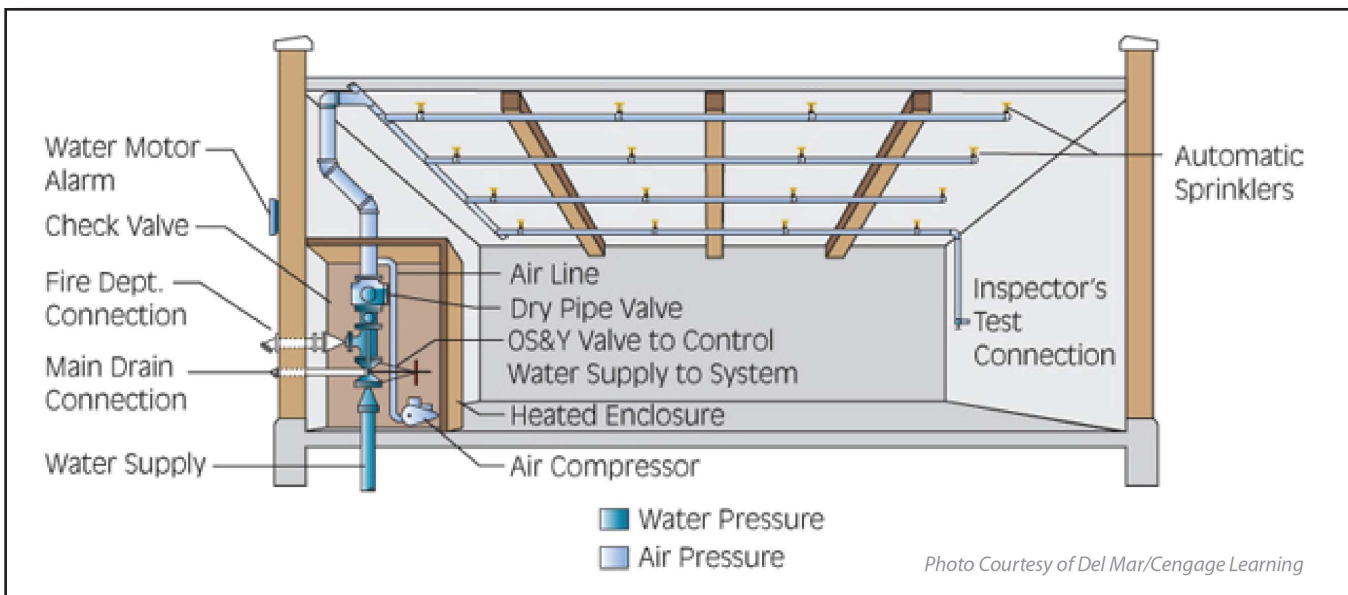

### Dry-Pipe Sprinkler System

parking garages, in outside canopies attached to heated buildings (in which a wet pipe system would be provided), or in refrigerated coolers.

System piping contains no water prior to system activation but rather is filled with air under pressure. A dry-pipe valve holds back the water supply and serves as the water/air interface. Most dry-pipe valves act on a pressure differential principle, in which the surface area of the valve face on the air side is greater than the surface area on the water side.



If a fire occurs and a sufficient amount of heat is generated, one or more sprinklers operate, causing system air pressure to drop. Once the air pressure falls below a predetermined level, the dry-pipe valve opens, allowing water to flow through the system to the open sprinklers. Dry-pipe systems are more complex than wet-pipe systems. They require a reliable air supply source and, because of the delay associated with water delivery from the dry-pipe valve to the open sprinklers, are subject to certain design limitations. These limitations can include restriction of system size, the need for additional components, such as accelerators and exhausters, and adjustments to the number of anticipated operating sprinklers. Any dry-pipe system

Figure 11-26 Pre-Action Sprinkler System



that has a capacity of over 500 gallons of water (inside the piping) are required to have an accelerator or exhauster.

## Pre-Action Systems

Pre-action sprinkler systems are specialized for use in locations where accidental activation is undesired, such as in museums with rare art works, manuscripts, or books; and Data Centers, for protection of computer equipment from accidental water discharge.

Pre-action systems are hybrids of wet, dry, and deluge systems, depending on the exact system goal, [Figure 11-26](#). There are two main sub-types of pre-action systems: single interlock, and double interlock.

### Single Interlock Systems

The operation of single interlock systems are similar to dry systems, except that these systems require a “preceding” fire detection event to occur. Typically the activation of a heat or smoke detector takes place prior to the “action” of water introduction into the system’s piping by opening the pre-action valve, which is a mechanically latched valve (i.e., similar to a deluge valve). In this way, the system is essentially converted from a dry system into a wet system. The intent is to reduce the undesirable time delay of water delivery to sprinklers that is inherent in dry systems. Prior to fire detection, if the sprinkler operates, or the piping system develops a leak, loss of air pressure in the piping will activate a trouble alarm. In this case, the pre-action valve will not open due to loss of supervisory pressure, and water will not enter the piping.

### Double Interlock Systems

The operation of double interlock systems is similar to deluge systems except that automatic sprinklers are used. These systems require that both a “preceding” fire detection event, typically the activation of a heat or smoke detector, and an automatic sprinkler operation take place prior to the “action” of water introduction into the system’s piping. Activation of either the fire detectors alone, or sprinklers alone, without the concurrent operation of the other, will not allow water to enter the piping. Because water does not enter the piping until a sprinkler operates, double interlock systems are considered as dry systems in terms of water delivery times, and similarly require a larger design area.

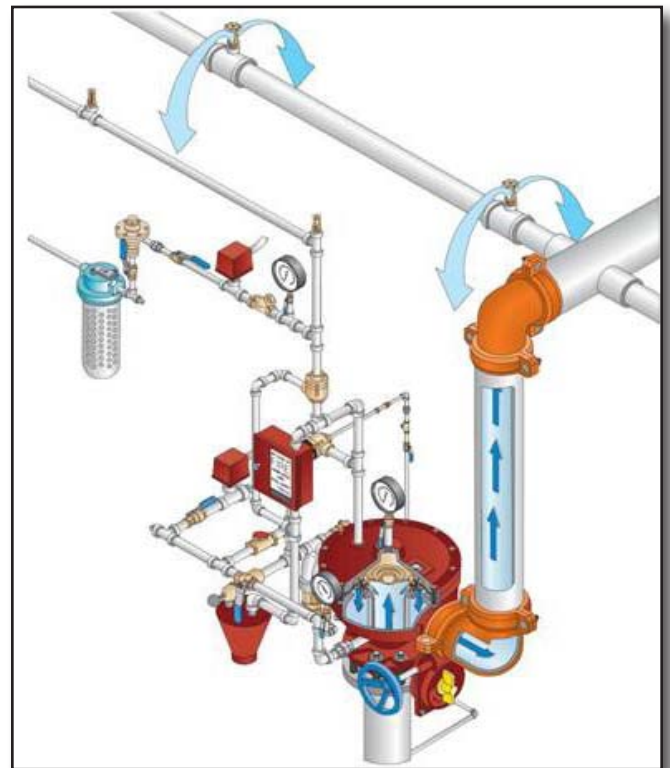

Figure 11-27 Deluge Sprinkler System



## Deluge Systems

Deluge systems are systems in which all sprinklers connected to the water piping system are open, in that the heat sensing operating element is removed, or specifically designed as such, [Figure 11-27](#). These systems are used for special hazards where rapid fire spread is a concern, as they provide a simultaneous application of water over the entire hazard. They are sometimes installed in personnel egress paths or building openings to slow travel of fire (e.g., openings in a fire-rated wall).

Water is not present in the piping until the system operates. Because the sprinkler orifices are open, the piping is at atmospheric pressure. To prevent the water supply pressure from forcing water into the piping, a deluge valve is used in the water supply connection, which is a mechanically latched valve. It is a non-resetting valve, and stays open once tripped.

Because the heat sensing elements present in the automatic sprinklers have been removed (resulting in open sprinklers), the deluge valve must be opened as signaled by a fire alarm system. The type of fire alarm initiating device is selected mainly based on the hazard (e.g., smoke detectors, heat detectors, or optical flame detectors). The initiation device signals the fire alarm panel, which in turn signals the deluge valve to open. Activation can also be manual, depending on the system goals. Manual activation is usually via an electric or pneumatic fire alarm pull station, which signals the fire alarm panel, which in turn signals the deluge valve to open.



# Automatic Fire Sprinkler System Components

## Sprinkler Heads

NFPA 13 establishes requirements regarding orifice diameter, thread type and diameter, temperature ratings, coatings, decorative finishes, and deflector design for all sprinkler heads used in automatic fire sprinkler systems.

The ½-inch orifice diameter sprinkler with ½-inch National Pipe Thread is considered the standard sprinkler and generally serves as the benchmark against which to compare the discharge of other sprinklers. Most sprinkler systems use ½-inch orifice diameter sprinklers. The sprinkler orifice and thread diameter increase respective to discharge capabilities.

Under normal conditions, the discharge of water from an automatic sprinkler is restrained by a cap or valve held tightly against the orifice by a system of levers and links or other releasing devices pressing down on the cap and anchored firmly by struts on the sprinkler.

### Fusible Link Sprinklers

Fusible link sprinklers incorporate two levers which are positioned between the nozzle cap and the outer sprinkler head frame to which the deflector is attached, [Figure 11-28](#). The levers are attached to each other via fusible plate with an alloy type solder. Heat acts upon this union, fusing or melting it, and compromises the support of the levers. Once the union has fused, water or air pressure pushes the levers and orifice cap out of the way.

### Frangible Bulb Sprinklers

A second type of operating element uses a frangible bulb. The small bulb, usually of glass, contains a liquid that does not completely fill the bulb, leaving a small air bubble trapped in it, [Figure 11-29](#). As heat expands the liquid, the bubble is compressed and finally absorbed by the liquid. Once the bubble disappears, the pressure rises substantially, and the bulb shatters, releasing the orifice cap. The exact operating temperature is regulated by adjusting the amount of liquid and the size of the bubble when the bulb is sealed. As the expected ambient temperature to which the sprinkler is exposed increases, sprinklers with higher temperature ratings must be used.

Other styles of thermo-sensitive operating elements employed to provide automatic discharge include bimetallic discs, fusible alloy pellets, and chemical pellets.



Figure 11-28 Fusible Link Sprinkler Head



Figure 11-29 Frangible Bulb Sprinkler Head

## Sprinkler Temperature Ratings

Maximum Ceiling Temperature	Temperature Rating	Temperature Classification	Frame Arm Color Code	Glass Bulb Color
100°F	135-170°F	Ordinary	Uncolored or Black	Orange (135°F) or Red (155°F)
150°F	175-225°F	Intermediate	White	Yellow (175°F) or Green (200°F)
225°F	250-300°F	High	Blue	Blue
300°F	325-375°F	Extra High	Red	Purple
375°F	400-475°F	Very Extra High	Green	Black
475°F	500-575°F	Ultra High	Orange	Black



Figure 11-30 Concealed Sprinkler Head

### Sprinkler Design

There are a multitude of sprinkler head design types specialized to meet the needs of almost any occupancy type or process. Sprinkler heads are designed for esthetic purposes, freezing environments, directional coverage, and corrosive environments.

Esthetic designs include recessed sprinklers, flush-type sprinklers, concealed sprinklers, Figure 11-30, and ornamental sprinklers. Recessed and flush-type sprinklers keep the majority of the sprinkler body within a housing in the ceiling. A concealed sprinkler is a type of ceiling sprinkler whose entire body, including the operating mechanism, is above its concealing cover plate. When a fire occurs, the cover plate drops at a ceiling temperature of 135°, exposing the thermo-sensitive assembly that fuses at 165°. Ornamental sprinklers have been decorated by plating or enameling to give desired finishes.



Figure 11-31 Pendant Sprinkler Deflector

Dry pendent and dry upright sprinklers are used to provide wet pipe sprinkler protection in unheated areas, such as freezers. These sprinklers use the same fusible elements inside the freezing environment as standard spray sprinklers, but the drop tube off of the sprinkler piping is dry. A complex assembly is used to keep the valve closed until the thermo-sensitive element fuses.

### Sprinkler Deflectors

Standard spray sprinklers are designed to be installed and operated in their proper position – that is, upright or pendant, as sometimes is indicated by a stamping upon the deflector bearing the appropriate word or the letters SSU (spray sprinkler upright) or SSP (spray sprinkler pendent). The important dif-



ference between the two standard spray sprinklers is the type of deflector installed on the sprinkler. Upright sprinkler heads are installed on the top of the sprinkler piping. Their umbrella-like deflector causes an upward spray of water to be redirected downward in a uniform pattern, [Figure 11-32](#). Pendent sprinkler heads are installed on the underside of the sprinkler piping. Their flat deflector breaks the downward spray into a uniform pattern of smaller droplets, [Figure 11-31](#).

Sidewall sprinklers have the components of standard spray sprinklers except for a special deflector, which discharges most of the water toward one side in a pattern somewhat resembling one-quarter of a sphere, [Figure 11-33](#). Extended coverage sidewall sprinklers are used in the horizontal position. They may be used in light-hazard occupancies, particularly in hotels and similar occupancies where a sprinkler system can be installed in an existing building without having piping exposed in living areas.

### Sprinkler Coatings

In areas where corrosion is a factor, sprinkler heads must be coated to protect the thermo-sensitive element. A complete covering of wax that has a melting point slightly below the temperature at which the sprinkler operates is the protective coating most commonly used. In recent years, sprinklers coatings of enamel, polyester, and Teflon® have been approved.



[Figure 11-33](#) Sidewall Sprinkler Deflector

### Sprinkler System Piping

A number of piping materials are acceptable for use in sprinkler systems. Steel, copper, and nonmetallic pipe materials are currently addressed by NFPA 13. Steel pipe has been used since 1896. Two types of plastic pipe were approved for use in the 1980's. Polybutylene (PB) and chlorinated polyvinyl chloride (CPVC), which are used in light-hazard or residential occupancies, [Figure 11-34](#).



[Figure 11-34](#) CPVC Sprinkler System Pipe

### Sprinkler System Control Valves

Control valves are used to shut off the water supply to a fire sprinkler system. Control valves should remain in the open position at all times with the exception of system modification or maintenance. The control valve is usually located on the main riser directly under the sprinkler alarm valve or electronic flow switch. It may also be located outside the structure, [Figure 11-35](#). This valve must be an indicating valve. Many control valves are monitored by an alarm system that will send an alert notification if the valve is closed.

High-rise structures may have floor control valves on each floor and/or section of floor. These valves



[Figure 11-35](#) Main Water Control Valve from Municipal Water Supply with OS&Y Valves



[Figure 11-32](#) Upright Sprinkler Deflector

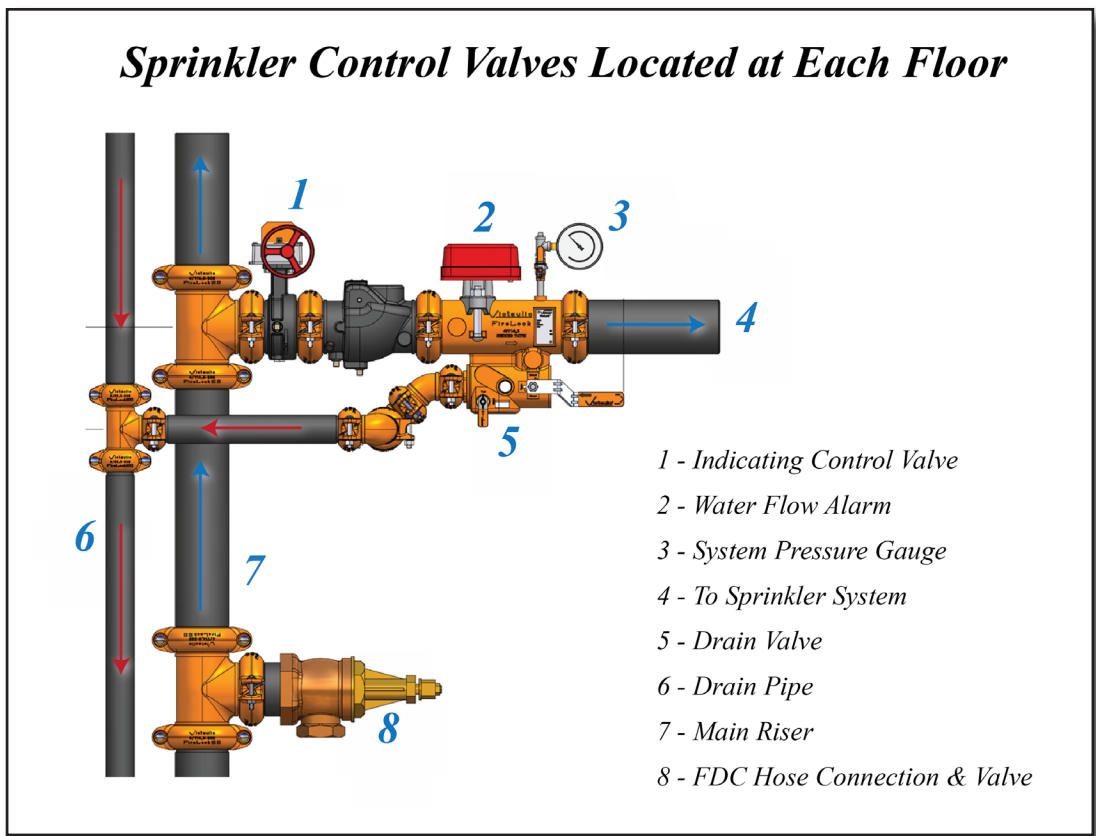

function in the same manner as the main control valve by controlling water flow in a smaller section of the fire sprinkler system. They are generally used to isolate the individual floors of the structure so the entire system does not have to be shut down. They must be an indicating valve and will generally be located near the spot where the riser enters the floor.

## Indicating Valves

Indicating valves are manually operated valves that will indicate from a distance whether the valve is open or closed. Common types of indicating valves include:

- Outside stem and yoke (OS&Y)
- Post indicator valve (PIV)
- Wall post indicator valve (WPIV)
- Indicating butterfly valve (IBV)

### Outside Stem and Yoke (OS&Y)

The rising stem feature of this valve is the indicator if the valve is open or closed, *Figure 11-36*. The stem rises as the valve wheel is turned clockwise to set the valve to the open position. The opposite end of the stem is equipped with a gate valve that moves in and out of the piping as the valve wheel is operated. OS&Y valves are often installed on, or near, the system riser.



Figure 11-36 Outside Stem & Yoke Valve (OS&Y)

## Post Indicator Valve (PIV)

A post indicator valve (PIV) is frequently installed outside of the structure. The indicating feature on this device is a viewing window with a sliding metal plate, [Figure 11-37](#). As the valve is operated with a special wrench, the stem, which is connected to the gate device on the end of the stem (the stem is internal to the post on a PIV), also repositions the sign. “OPEN” will be displayed in the small viewing window on the side of the PIV housing. Likewise, when the valve is operated to the closed position, the sign labeled “SHUT” or “CLOSED” will be displayed in the viewing window.



Figure 11-37 Post Indicator Valve (left), Wall Post Indicator Valve (top right), Indicating Butterfly Valve (bottom right)

## Wall Post Indicator Valve (WPIV)

A wall post indicator valve (WPIV) is similar to a PIV with the exception that they are wall-mounted or have a valve stem that runs through the outside wall of the structure, [Figure 11-37](#). The viewing window and valve operating nut are located on the exterior side of the wall. The key to indication is the same as the PIV.

## Indicating Butterfly Valve (IBV)

Indicating butterfly valves (IBV) do not have the same type of physical features of either the OS&Y valve or the PIV valve; thus, it must use an indicating feature that is substantially different from either of the first two valves. The indicating feature with an IBV is usually a directional arrow or brightly colored paddle, mounted on the housing of the valve, [Figure 11-37](#). This feature points the “position” of the valve. When the valve is open, the arrow or paddle is in line with the flow direction of the water pipe. When the valve is in the closed position, the arrow points in a direction perpendicular to the pipe and water flow.

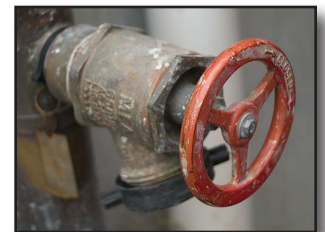

Figure 11-38 Non-indicating Globe Valve

## Non-indicating Valve

These valves are utilized as the main drain, test valves, and auxiliary valves. As the name implies, the position of the valve cannot be determined at a glance. The most common type of non-indicating valve is the globe valve, [Figure 11-38](#).

## Check Valve (Clapper Valve)

These valves are constructed to allow water to flow in only one direction. The valve will open on a pivot with water pressure on the supply or inlet side of the valve. Higher pressure on the system



Figure 11-39 Check Valve (center) with two OS&Y Valves in the Closed Position (ends)



Figure 11-40 Hydraulic/  
Mechanical Waterflow  
Alarm

side of the valve will close the valve against the valve seat, preventing water flow in the opposite direction, [Figure 11-39](#). The designed direction of water flow through the valve will be identified by an arrow cast into the side of the valve assembly. Flow direction can also be determined by the position of the pivot casting. A casting nut will be located closer to the water entrance of the valve assembly. Typically, these valves will be used as alarm check valves or inside the fire department connection. These valves are also used to prevent the water within the fire sprinkler system from entering the domestic water supply and are commonly referred to as “back flow preventor” valves.

## Water Flow Alarm

Water flow alarms are essential to all automatic fire sprinkler systems. As stated earlier, the alarm is used to alert occupants to the flow of water through the sprinkler system and the possibility of fire. Water flow alarms are generated in one of two ways; hydraulically (mechanical) or electrically.

Hydraulically operated alarms are often called “water motor gongs.” These devices operate much like a miniature version of an old water wheel. As water flow turns the paddles of the small water wheel, it operates a striking mechanism that repeatedly strikes a large bell sounding the alarm, [Figure 11-40](#).

Water flow alarms may be signaled using electrically operated fire alarm notification appliances, such as vibrating bells, horns, sirens, chimes, and several varieties of flashing lights. Such signals usually are initiated by electrical switches incorporated into some type of pressure- or flow-operated device, [Figure 11-41](#).



Figure 11-41 Electric Waterflow Alarm

## Fire Protection System Pump

In addition to the water supply from the municipal system, many fire protection systems, such as those found in high-rise buildings, require the use of a fire pump to increase pressure. Most fire pumps are found in the lower floors of a building and are either diesel or electrically powered. Modern pumps start automatically when the pressure in the system drops to a predetermined level to supplement the pressure from the municipal water supply.

Because fire protection systems in high-rise buildings require a pressure of 100 psi to highest or most remote outlet (typically the roof), fire pumps may be required to pump pressures in excess of 300 psi. at ground level. During firefighting operations in buildings with fire pumps, hoses connected to the FDC are used for the purpose of backing up the pump in the event it fails to deliver the appropriate pressures.

For new high-rise buildings, the fire code requires



Figure 11-42 Fire Protection System Pump



a secondary supply of water to feed the fire pump in the event that water from the municipal system is cut off, such as from an earthquake. This secondary supply of water is achieved through the use of large concrete cisterns, often over 100,000 gallons, located within the building or onsite.

## Shutting Down Fire Protection Systems

Upon determining that the fire has been extinguished and there no longer is a need for the system to continue activation, the fire protection system must be shut down. As a general rule, you should work from the source of the activation and move backwards through the system towards the water supply source. This is done to reduce the number of outlets or areas shut-down in the entire structure or area. Below is the progression for shutting down a fire protection system. If you are unable to succeed at one step, then you move to the next until the system has stopped discharging.

- Stop/plug the sprinkler head using sprinkler tongs, redwood plugs or door wedges, [Figure 11-43](#).
- Shutdown down the zone/floor control valve which is typically found in the stairwell on the main riser, [Figure 11-44](#), or may be located overhead in the plenum space, [Figure 11-45](#). Open drain valve.
- Shutdown the primary feeder valve to the entire FPS via the PIV or OS&Y and open drain valve.

It is important to note that some FPS are supplied by two risers on either end of the building creating a looped system. If this is the case, you will need to shut down the control valves on both risers to isolate the sprinkler head.

When shutting down the water supply to the entire fire protection system on multi-story buildings, you may continue to get water discharging from the system. This is due to the residual pressure left in the system and water draining from upper floors. Depending on the size of the building, this can last up to 15 minutes. This is why it is preferable to isolate the floor by shutting down the secondary feeder valve in the stairwell.



Figure 11-43 Sprinkler Tongs & Wedges



Figure 11-44 Zone/Floor Control Valve Located on Main Riser in Stairwell



Figure 11-45 Zone/Floor Control Valve Located Overhead in the Plenum Space



## Restoring Fire Protection Systems

Once the fire or hazard has been mitigated, the fire protection system must be restored to working condition prior to turning the building back over to the owner or occupant.

Restoring the fire protection system includes the following action by firefighters:

- Replace sprinkler heads from the spare sprinkler supply located within the fire control room if available, [Figure 11-46](#), or use spare heads from truck company (water supply to system must be shut-down)
- Restore water to system for sprinkler and wet-standpipe systems
- Drain water from dry standpipe-systems and ensure valves are closed
- Ensure that all audible and visual alarm devices are no longer activating
- Reset alarm panel and ensure that no other alarms exist
- Salvage or water removal



Figure 11-46 On-Site Sprinkler Head Replacements

If the firefighters are unable to fully restore a fire protection system, the owner or manager is responsible to contact the alarm company for service and staff and a 24 hour fire watch until the system is operable again.





# Non-Water Based Fire Protection Systems

## Halogenated Agents

Halogenated extinguishing agents are hydrocarbons in which one or more hydrogen atoms have been replaced by atoms from the halogen series: fluorine, chlorine, bromine or iodine. Halogenated agents are used both in portable fire extinguishers and in fixed extinguishing systems, [Figure 11-47](#). Halon 1211 has been most often used in manually applied extinguishers and local application-type fixed systems. Halon 1301 has most often been used in total flooding-type fixed systems, [Figure 11-48](#). NFPA 12A Standard on Halon 1301 Fire Extinguishing Systems and 12B Standard on Halon 1211 Fire Extinguishing Systems cover the requirements for Halon 1301 and Halon 1211 systems, respectively.

The extinguishing mechanism of the halogenated agents is not clearly understood. However, a chemical reaction appears to interfere with the combustion processes. They break the chemical chain reaction component of the flame process. In total flooding systems, the effectiveness of the halogenated agents on flammable liquid and vapor fires is quite dramatic. Rapid and complete extinguishment is obtained with low concentrations of agent. The effectiveness of halogenated agents on Class A fires is less predictable.

Halon has been identified as stratospheric ozone-depleting substance. In fact, halon has been identified as the most potent of all ozone-depleting substances. Production of Halon 1301 and 1211 ceased in developed countries in 1994. Halon is now recycled to avoid release into the atmosphere. It also negates the need to produce new halogenated agents to maintain systems in place. In addition to their effects on the stratosphere, halogenated agents can be toxic to personnel in the fire environment.

The San Diego Fire-Rescue Department uses Halon 1211 on the Oshkosh P-19 crash rescue apparatus. The system is essentially a large fire extinguisher. Five hundred pounds of Halon 1211 are stored as a liquid in a cylinder. Nitrogen gas is used for expellant pressure. The extinguishing agent is discharged through a one hundred foot, one inch red line.



Figure 11-47 Halon Extinguishing System



Figure 11-48 Halon Storage System



## Halon Replacement Agents and Systems

There are currently over 12 commercialized total flooding, clean agent alternatives to Halon 1301, and development continues on others. Clean fire suppression agents are defined as fire extinguishants that vaporize readily and leave no residue. Clean agent halon replacements fall into two broad categories: (1) halo-carbon compounds and (2) inert gases and mixtures.

Halo-carbon compounds extinguish fires by inhibiting the chemical chain reaction and oxygen depletion. Inert gas agents suppress flames by reducing the flame temperature below thresholds necessary to maintain combustion reactions.

NFPA 2001 contains requirements for the approval and post-installation inspection and test of clean agent systems. Most clean agent suppression systems use a total flooding application. This application is effective for flammable liquid and concealed area fires. These systems rely on a reasonably intact enclosure with doors closed and external ventilation secured prior to discharge.

### Carbon Dioxide Systems

Carbon dioxide has been in widespread use for many years and is likely to have safely extinguished more fires than any other gaseous fire-extinguishing agent. Carbon dioxide has a number of properties that make it a desirable fire-extinguishing agent. It is noncombustible, it does not react with most substances, and it provides its own pressure for discharge from the storage container. Since carbon dioxide is a gas, it can penetrate and spread to all parts of a fire area. As a gas, it will not conduct electricity and, therefore, can be used on energized electrical equipment. It leaves no residue, thus eliminating cleanup of the agent itself.



Figure 11-49 Carbon Dioxide System Storage Tanks

The primary mechanism by which carbon dioxide extinguishes fire is oxygen reduction (smothering). Carbon dioxide gas has a density of one and one-half times the density of air at the same temperature. This greater vapor density displaces the oxygen in the discharge area.

Two basic methods are used to apply carbon dioxide. One method is to discharge a sufficient amount of the agent into an enclosure to create an extinguishing atmosphere throughout the enclosed area. This is called “total flooding.” Total flooding should not be used in normally occupied spaces unless arrangements are made to ensure evacuation before discharge. The second method is to discharge the agent directly onto the burning material without relying on an enclosure to retain the carbon dioxide. This is called “local ap-



Media 11-1 CO<sub>2</sub> Extinguishing System



plication.” Other methods include hand hose lines, standpipe systems, and mobile supply, extended discharge, and special applications.

## Chemical Extinguishing Systems

Chemical extinguishing systems are classified as either dry chemical or wet chemical systems. NFPA 17 Standard for Dry Chemical Extinguishing Systems and NFPA 17A Standard for Wet Chemical Extinguishing Systems cover the requirements and applications for dry chemical and wet chemical systems respectively.

### Dry Chemical Extinguishing Systems

Dry chemical extinguishing systems can be used in those situations where quick extinguishment is desired and where re-ignition sources are not present. Dry chemical systems are used primarily for flammable liquid fire hazards, such as dip tanks, flammable liquid storage rooms, and areas where flammable liquid spills may occur. Dry chemical extinguishing systems were used in older hood and duct systems that use animal fat as the cooking medium. Dry chemical causes extinguishment primarily through the chain-breaking reaction and also through smothering, cooling, and radiation shielding. Extinguishing by smothering is accomplished by saponification. Saponification is the process of chemically converting the fatty acid contained in the cooking oil to soap, or foam, and forming a surface coating that smothers the fire. Since dry chemical is electrically non conductive, extinguishing systems using this agent can be used on electrical equipment that is subject to flammable liquid fires. Dry chemical system protection is not recommended for delicate electrical equipment, such as telephone switchboards and electronic computers.



Figure 11-50 Dry Chemical System Storage Tanks

Dry chemical extinguishing systems can be configured as total flooding systems, Figure 11-50, or local application systems, Figure 11-51. Total flooding systems cover the entire hazard area, and require the hazard area to be enclosed. Local application systems apply the dry chemical extinguishing agent directly on the hazardous operation or storage when the area cannot be completely enclosed.

### Wet Chemical Extinguishing Systems

Wet chemical extinguishing agents are essentially dry chemical extinguishing agents mixed in water and other additives. Wet chemical extinguishing agents were developed because vegetable oils have a lower ignition temperature and lower fatty acid content than animal fats. Energy-efficient cooking equipment also allows the oils to retain their heat

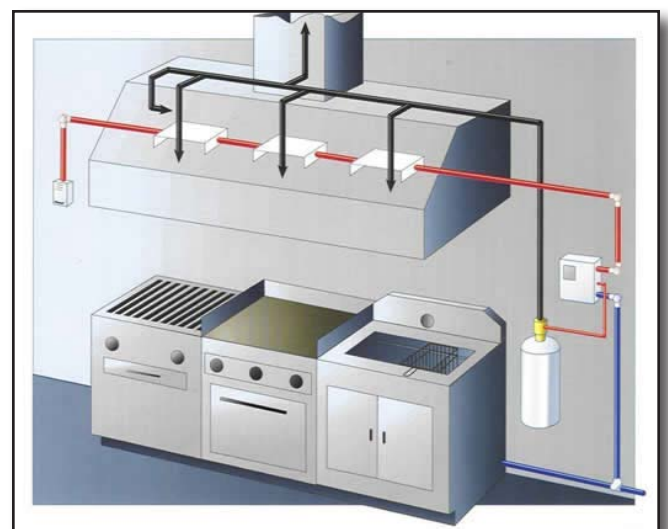

Figure 11-51 Wet Chemical System - “Hood System”



### Media 11-2 Wet Chemical Extinguishing System

for greater lengths of time. When wet chemical extinguishing agents are sprayed on a grease fire, they interact immediately with the grease and saponify, forming a blanket of foam over the surface on which they are sprayed. This extinguishes the fire by a combination of two primary methods: smothering and cooling.

Wet chemical systems are local application systems. Local application systems are practical in those situations where the hazard can be isolated from other hazards so that the fire will not spread beyond the area protected, and where the entire hazard can be protected. The nozzles are arranged to discharge directly onto the fire or burning surface such as deep-fat fryers, griddles, and stoves.

Both dry chemical and wet chemical extinguishing systems are actuated by either automatic or manual means. Automatic activation is provided by fusible link or heat detector operation. Manual activation occurs by the use of a manual pull station located adjacent to the means of egress from the room. Manual pull stations provide a backup source of system operation and must be clearly identified. Automatic fuel or electricity shut-off for cooking equipment is also required.

### Foam Extinguishing Agents and Systems

Foam is produced by mixing a foam concentrate with water at the appropriate concentration, and then aerating and agitating the solution to form the bubble structure. Foams are defined by their expansion ratio, which is the final foam volume to the original foam solution volume before adding air. They are arbitrarily subdivided into three ranges:

- Low Expansion Foam – expansion up to 20:1
- Medium Expansion Foam– expansion 20 to 200:1
- High Expansion Foam– expansion 200 to 1000:1

Low expansion foam is used principally to extinguish burning flammable or combustible liquid spill or tank fires by application to develop a cooling, coherent blanket. A foam blanket covering a tank's liquid surface can prevent vapor transmission. Fuel spills are quickly rendered safe by foam blanketing. Foam is of great importance where air crafts are fueled and operated. Sudden, large fuel spills resulting from aircraft accidents or malfunction require rapid foam application. Hangar fire protection is best accomplished by properly designed foam systems.

Fire-fighting foam is an effective agent for combating flammable and combustible fuel fires. Various types of foam are applied in different manners, but all act to suppress flammable vapors and cool fuel surfaces. Foam agents are used to combat fires in various hazards, including tank farms, airfields, aircraft hangars, and flammable liquid hazards.



Figure 11-52 Foam System Storage Tanks



### Media 11-3 Faom Extinguishing System



# Summary

Firefighters will encounter many fire protection systems during their career. The ability to identify the major components of modern water delivery systems, describe detection and alarm systems, identify the classes and types of standpipes, identify the system types and basic operating principles of water-based fire protection systems, identify and describe the major components of automatic fire sprinkler systems, state the effectiveness of wet pipe sprinkler systems for the protection of life and property; identify the characteristics of upright, pendant, and horizontal sprinkler heads, describe the temperature ratings and associated color ratings for sprinkler heads, and to identify system types and concepts for fire suppression without water will be essential to efficient fire ground operations.



# Media & Link Index



CO2 Extinguishing System in Metal Shop Fire (Security Camera Footage)



Wet Chemical / Hood System Test Fire



CAF System Test on Polar Solvent Fire



# References

1. Casey Cavanaugh Grant, PE, The Birth of NFPA, 1996
2. NFPA, Operation of Fire Protection Systems, 2003
3. City of San Diego Policy FS-0410
4. NFPA, "U.S. Experience with Sprinklers and Other Fire Extinguishing Equipment", John R. Hall, Jr., September 2010
5. NFPA 13, Standard for the Installation of Sprinkler Systems
6. DelMar Cengage Firefighters Handbook
7. IFSTA 5th Edition Chapter 16, Fire Detection, Alarm, and Suppression
8. NFPA Fire Protection Handbook, Section 16, Eighteenth Edition, 1997
9. SimplexGrimmel, Simplex 4100U Fire Alarm Panel Operator's Manual, 2006

# Credits

**Writers:**

Michael McBride

**Layout & Editing:**

John Brubaker / Sergio Perreria

**Media:**

John Brubaker / Michael McBride / Kurtis Benentt /

**Grammatical Editing:**

***NOTE: If you have any additional information or content that you feel would be appropriate to contribute to this Chapter or would like to report any errors or misrepresentations, please contact the SDFD Training Division or email the Drill Manual Revision Staff at***

***SDFDDrillManualTeam@SanDiego.gov***

